

TAPELIGHT PROFILES

design by Spazio



EDGE PROFILE

- Profile for ceiling edge applications
- Extrusion made in anodised aluminium
- Available in 2m lengths
- Diffuser, endcaps and mounting clips are available as accessories
- Requires open or closed LEDtape and accessories (Fig. 1)

STEP BULLNOSE PROFILE

- Profile for step applications
- Extrusion made in anodised aluminium
- Available in 2m lengths
- Diffuser, endcaps and mounting clips are available as accessories
- Requires open or closed LEDtape and accessories (Fig. 1)

50x32 PROFILES

- The extrusion is made in anodised aluminium
- Available in 2m lengths
- Diffuser, endcaps and mounting clips are available as accessories
- Requires open or closed LEDtape and accessories (Fig. 1)

35x35 PROFILES

- The extrusion is made in anodised aluminium
- Available in 2m lengths
- Diffuser, endcaps and mounting clips are available as accessories
- Requires open or closed LEDtape and accessories (Fig. 1)

Fig. 1



TAPELIGHT PROFILES

design by Spazio



ZERO PROFILES

- The extrusion is made in anodised aluminium
- Available in 2m lengths
- Diffuser, endcaps and mounting clips are available as accessories
- Diffusers Available:
 - Square opal
 - Flat opal
- Requires open or closed LEDtape and accessories (Fig. 1)



CORNER PROFILE

- Profile for corner applications. Lumen source positioning at 45°
- Extrusion made in anodised aluminium
- Available in 2m lengths
- Diffuser, endcaps and mounting clips are available as accessories
- Diffusers available:
 - Round
 - Square
- Requires open or closed LEDtape and accessories (Fig. 1)



SLIM PROFILES

- Slimline profile
- Extrusion made in anodised aluminium
- Available in 2m lengths
- Diffuser, endcaps and mounting clips are available as accessories
- Available as a surface or recessed version
- Requires open or closed LEDtape and accessories (Fig. 1)



PETIT PROFILE

- Thin square profile
- Extrusion made in anodised aluminium
- Available in 2m lengths
- Diffuser, endcaps and mounting clips are available as accessories
- Requires open or closed LEDtape and accessories (Fig. 1)

Fig. 1



TAPELIGHT PROFILES

design by Spazio



EDGE PROFILE

To be used with LEDtape + accessories



code
2m Edge profile
1046.05

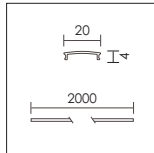
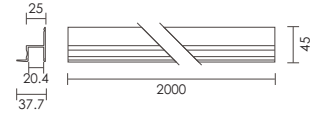

code
Flat opal diffuser
1046.D

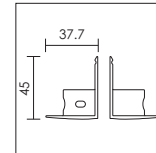

code
End cap (pair)
1046.EC

STEP BULLNOSE PROFILE

To be used with LEDtape + accessories



code
2m Step profile
1045.05

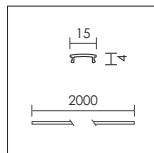
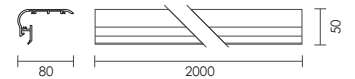

code
Flat opal diffuser
1045.D

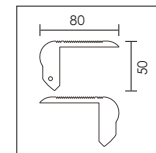

code
End caps (pair)
1045.EC

TAPELIGHT PROFILES

design by Spazio



05
Natural
Anodised

35 x 35 SURFACE

To be used with LEDtape + accessories



code
2m profile
1043.1.05

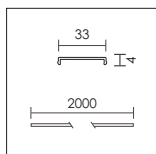
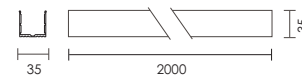

code
Flat diffuser
1043.D

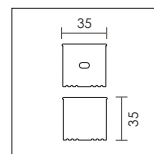
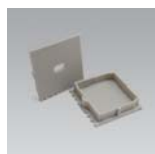

code
End caps (pair)
1043.1.EC

35 x 35 RECESSED

To be used with LEDtape + accessories



code
2m profile
1043.2.05

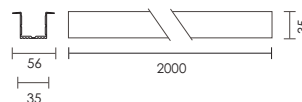

Cut out: 35 x 2000

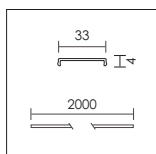

code
Flat diffuser
1043.D

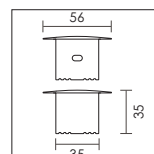
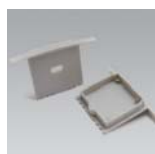

code
End caps (pair)
1043.2.EC

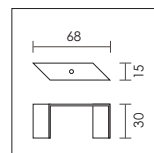

code
Mounting clip
1043.2.MC

TAPELIGHT PROFILES

design by Spazio



50 x 32 SURFACE

To be used with LEDtape + accessories



code
2m profile
1044.1.05

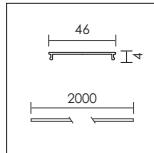
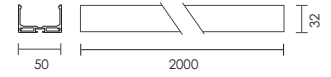

code
Flat diffuser
1044.D

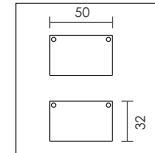

code
End caps (pair)
1044.1.EC

50 x 32 RECESSED

To be used with LEDtape + accessories



code
2m profile
1044.2.05

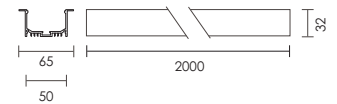

Cut out: 50 x 2000

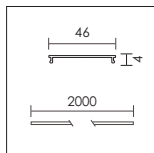

code
Flat diffuser
1044.D

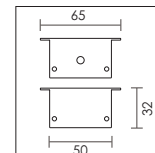

code
End caps (pair)
1044.2.EC

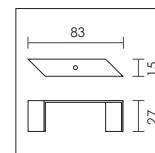

code
Mounting clip
1044.2.MC

TAPELIGHT PROFILES

design by Spazio

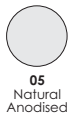

ZERO SURFACE

To be used with LEDtape + accessories



code
2m profile
1037.1.2000.05

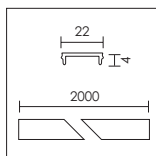
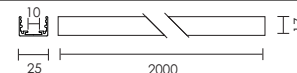

code
Flat diffuser
1037.D.1

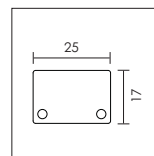

code
Flat diffuser end cap
1037.1.EC.2

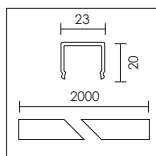

code
Square diffuser
1037.D.2

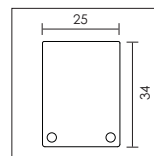

code
Square diffuser end cap
1037.3.EC.2

ZERO RECESSED

To be used with LEDtape + accessories

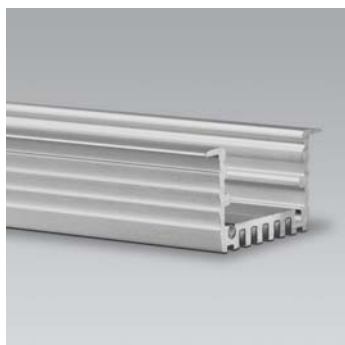

code
2m profile
1037.2.2000.05

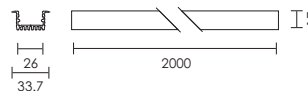

Cut out: 26 x 2000

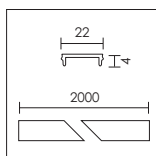

code
Flat diffuser
1037.D.1

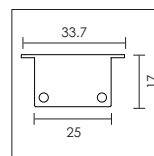

code
Flat end cap
1037.2.EC.2

TAPELIGHT PROFILES

design by Spazio



CORNER PROFILE WITH ROUND DIFFUSER

To be used with LEDtape + accessories



code
2m profile
1040.05

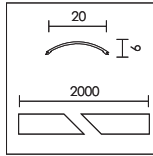
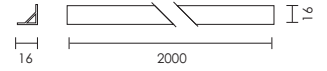

code
Round diffuser
1040.1.D

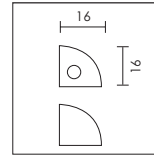

code
Round end caps (pair)
1040.1.EC

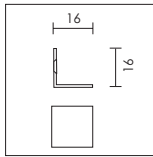

code
Mounting clip
1040.MC

CORNER PROFILE WITH SQUARE DIFFUSER

To be used with LEDtape + accessories



code
2m profile
1040.05

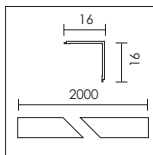
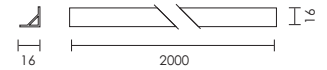

code
Square diffuser
1040.2.D

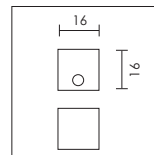

code
Square end caps (pair)
1040.2.EC

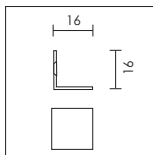

code
Mounting clip
1040.MC

TAPELIGHT PROFILES

design by Spazio

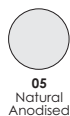

SLIM SURFACE

To be used with LEDtape + accessories



code
2m profile
1039.1.05

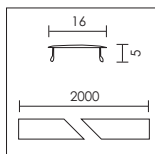
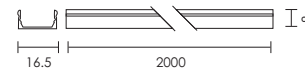

code
Slim profile diffuser 2m
1039.D

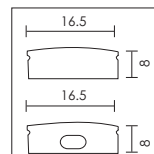

code
Slim surface end cap (pair)
1039.1.EC

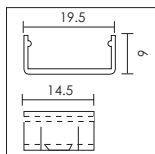

code
Slim surface mounting clip
1039.1.MC

SLIM RECESSED

To be used with LEDtape + accessories



code
2m profile
1039.2.05

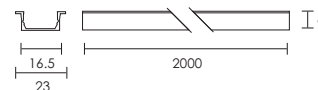

Cut out: 16.5 x 2000

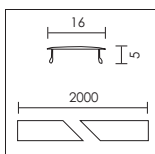

code
Slim profile diffuser 2m
1039.D

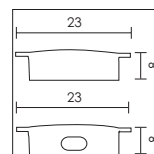

code
Slim recessed end cap (pair)
1039.2.EC

TAPELIGHT PROFILES

design by Spazio



PETITE PROFILE

To be used with LEDtape + accessories

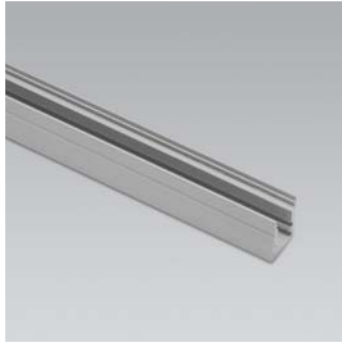

code
2m profile
1042.05

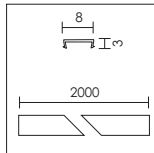
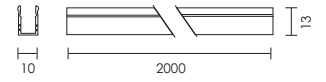

code
Profile diffuser 2m
1042.D

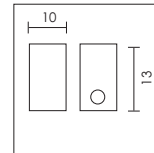

code
End cap (pair)
1042.EC

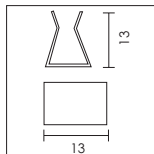
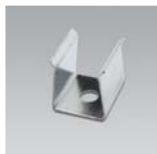

code
Mounting clip
1042.MC

BASE 3 HEATSINK



code
2m aluminium strip
1036.10177.2M

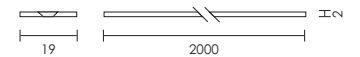

PROFILE INSTALLATION

design by Spazio



Attach the Zero extrusion to required surface



Remove the application tape from LEDtape and apply to Zero surf.



Applied LEDtape



Attach the desired diffuser, Square or Flat opal diffuser available

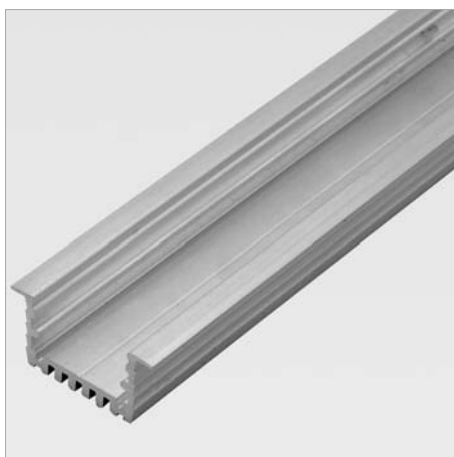

Zero recessed extrusion



Remove the application tape from LEDtape and apply to Zero Rec.



Applied LEDtape



Slide or attach desired diffuser, Square or Flat opal diffuser available

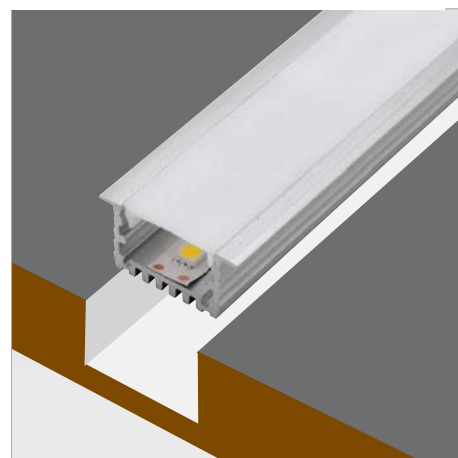

Make the necessary cut out and and install the Zero Recessed